

A DN 30 - 50

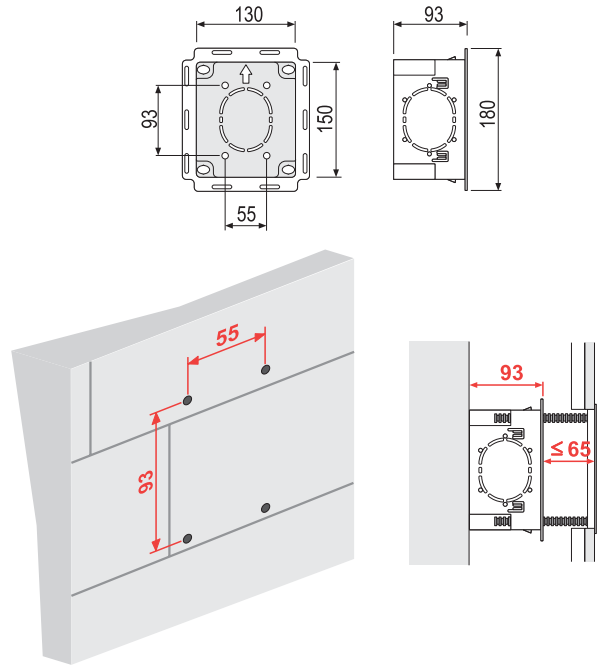

B DN 70 - 100

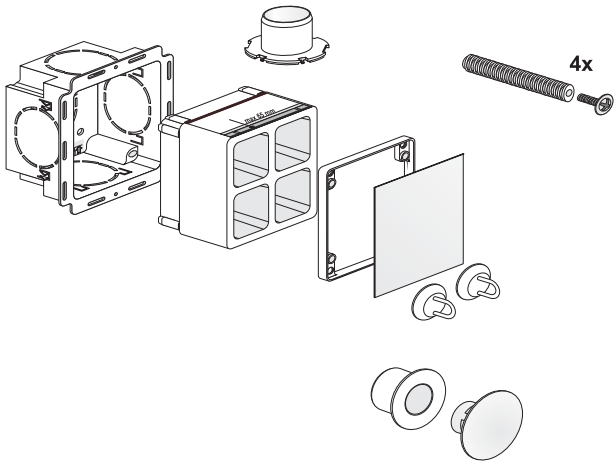
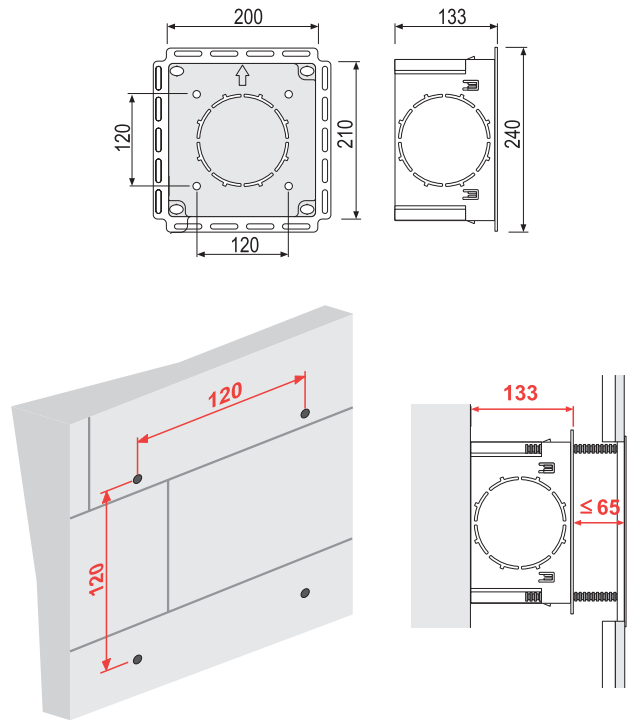
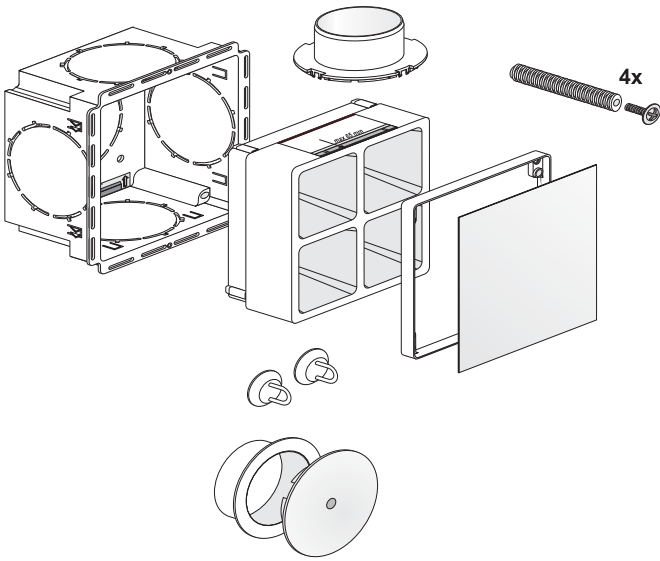

EM.305.43..0000 · III/13

1

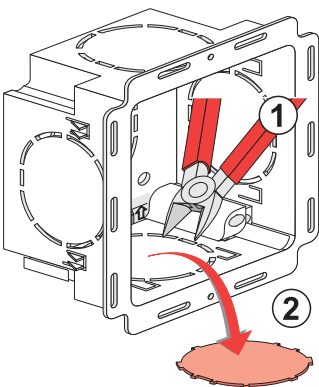

2

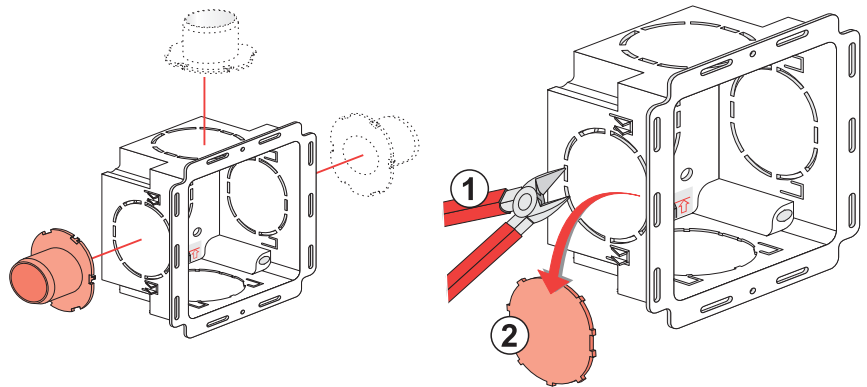

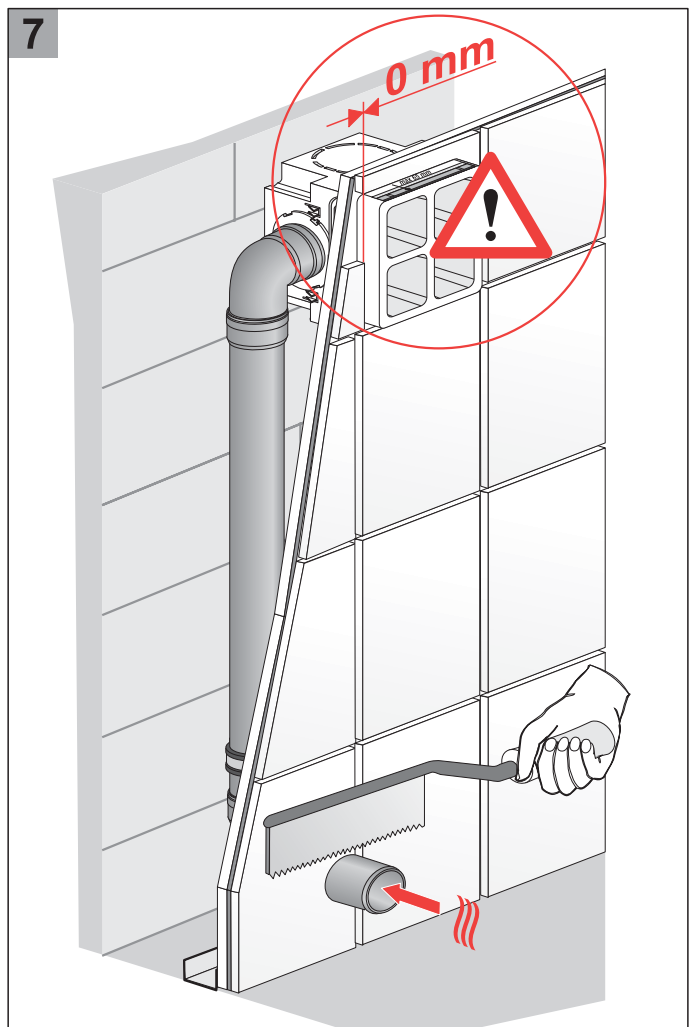
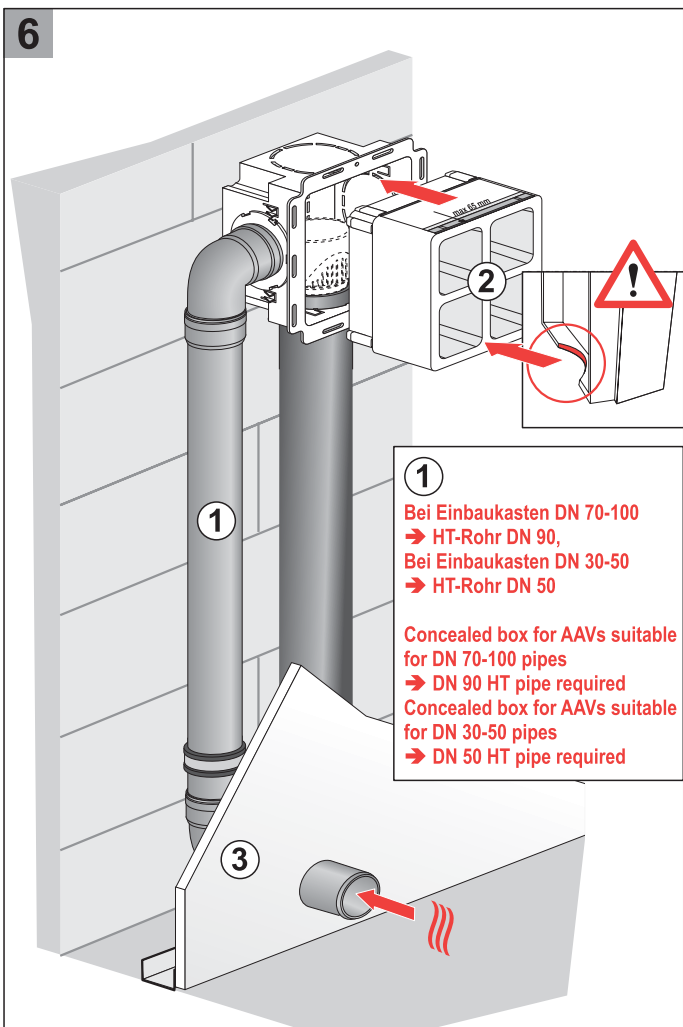
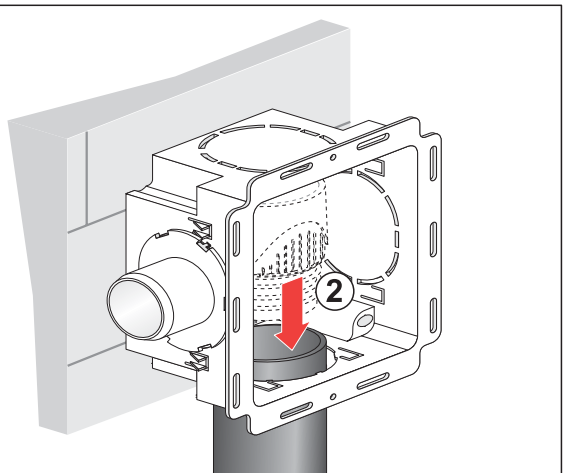
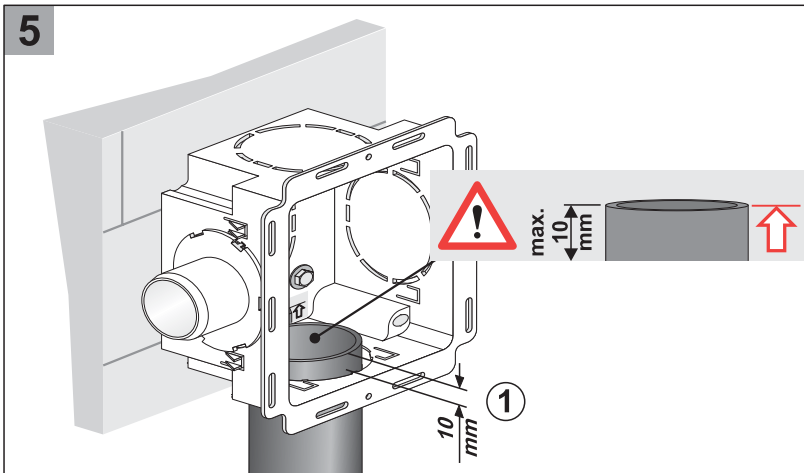
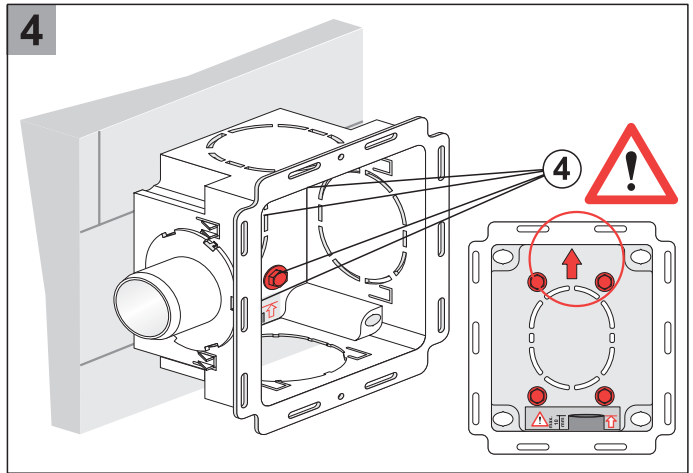
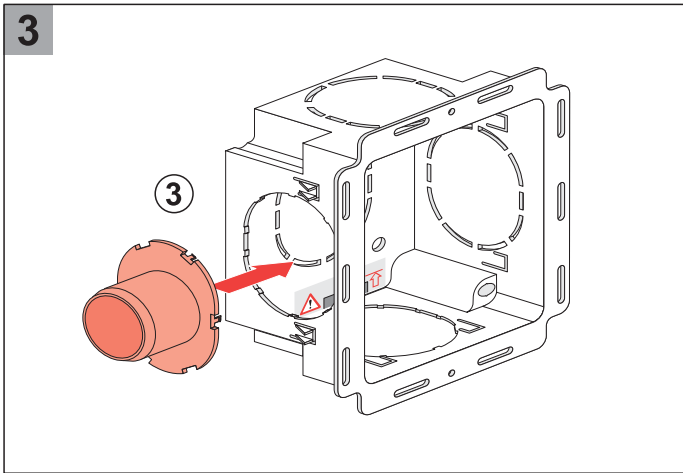

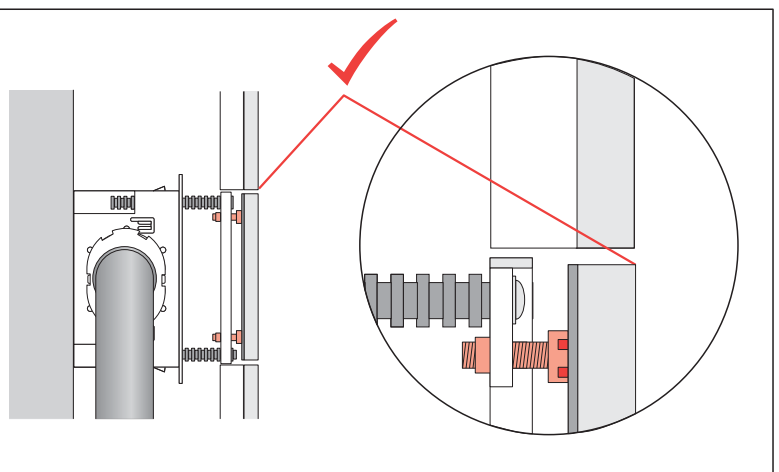
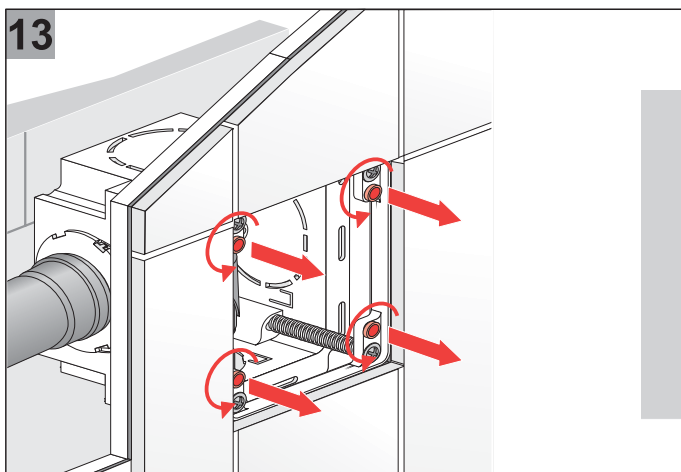
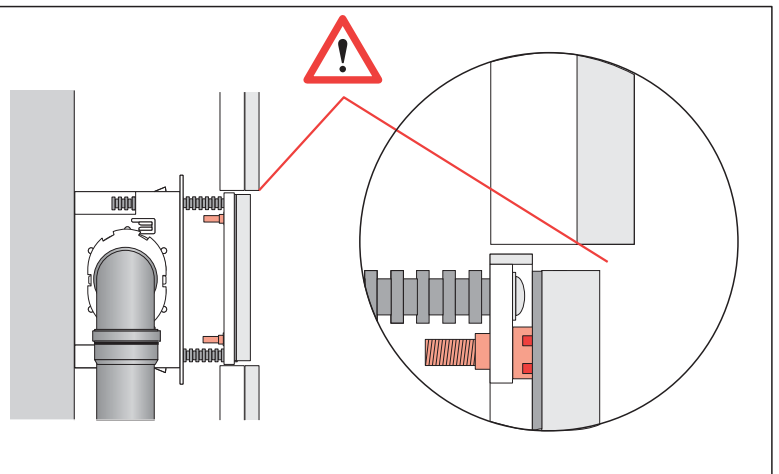
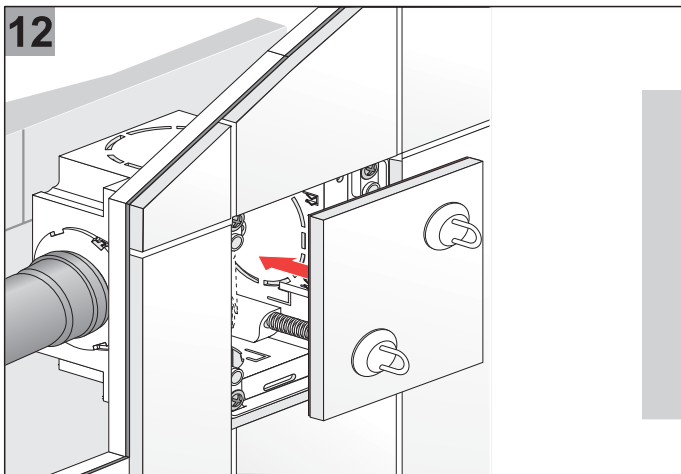
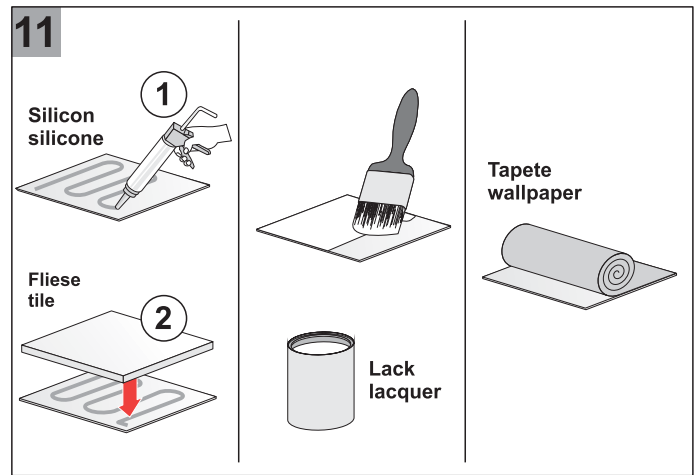
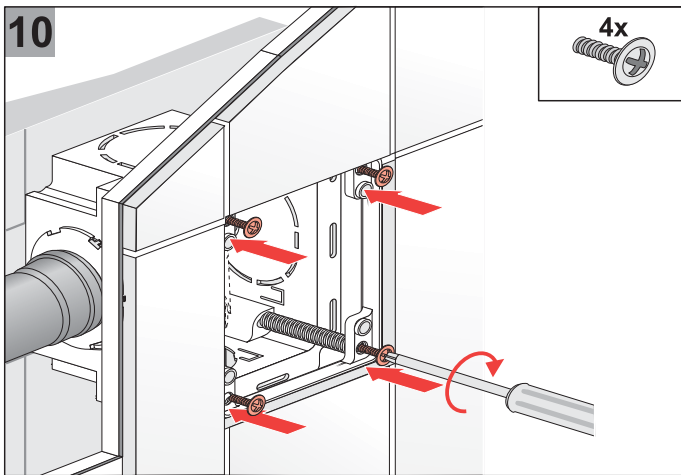
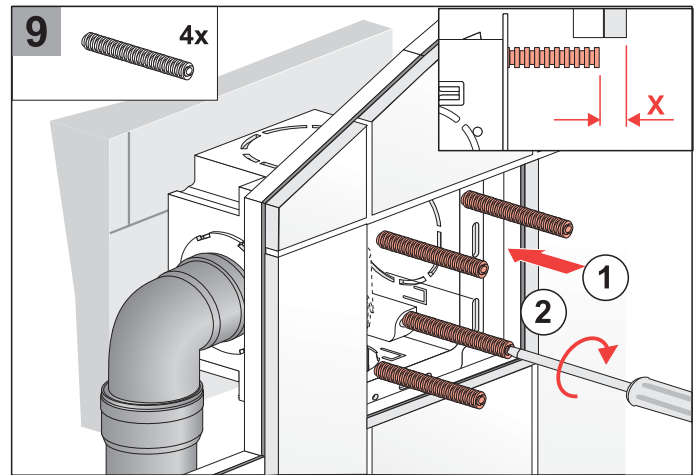
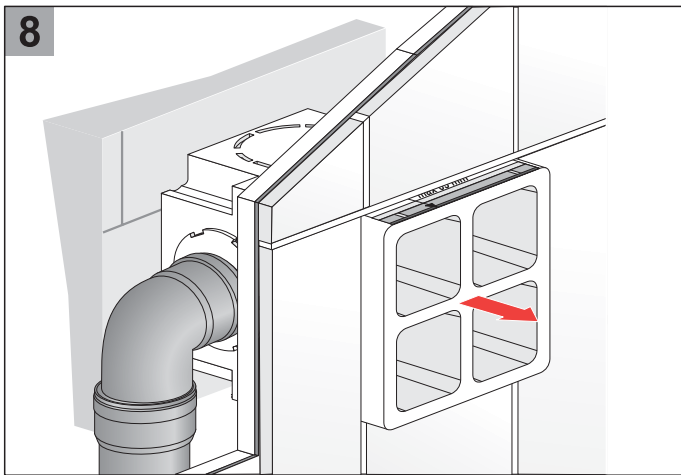

14

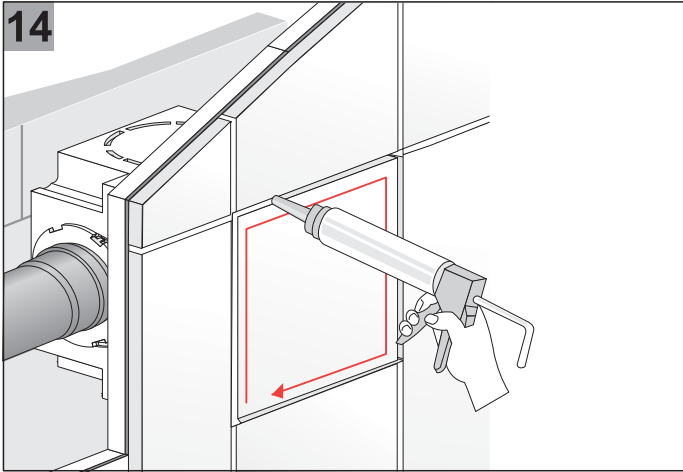

15

