



ventilair® / ventilair active®

Applications

Technical information



AIR-ADMITTANCE VALVES AND ACCESSORIES

WWW.SANIT.COM

## ventilair® – air-admittance valves for waste water pipes

General information	Pages	3-4
Product description, function, nominal diameters, maintenance, frost protection, installation possibilities, example calculation	Pages	5-9

### ventilair®



ventilair® air-admittance valves for waste water pipes	Pages	6-9
--	-------	-----



ventilair® commercial construction, housing complexes, multi-storey building	Pages	10-12
--	-------	-------



Plastic trap connectors with ventilair® air-admittance valve	Page	13
--	------	----



ventilair® air-admittance valve horizontal – NEW	Pages	13
--	-------	----



Built-in wall boxes	Pages	14-17
---------------------	-------	-------



ventilair® air-admittance valve for outdoor use	Pages	18-19
---	-------	-------

### Air-admittance valves for the ventilation of individual objects



Chromed trap connectors with chromed air-admittance valve	Page	20
---	------	----



Air-admittance valves for the ventilation of individual objects according to DIN EN 12380	Page	21
---	------	----

### ventilair active®



Two-way vent valve with activated carbon filter pad for containers, toilet lifting systems and open ventilation systems, domestic micro lifting systems	Pages	22-31
---	-------	-------

## GENERAL INFORMATION

### Air-admittance valves for waste water pipes

#### The essentials

Air-admittance valves can be used in waste water pipes following the acknowledged rules of technology to reduce negative pressure. The installation recommendations are contained in the European and German DIN EN 12056-2 and DIN 1986-100 standards.

Air-admittance valves can also be installed in deviation from the recommendations if when installing waste water systems certain structural requirements need to be taken into consideration.

These can arise as a result of the Energy Saving Ordinance, for building conservation reasons or because of structural requirements. Deviations from the standards should be contractually regulated.

Air-admittance valves must meet the requirements of DIN EN 12380 and be labelled with the relevant type class.

#### Classification of air-admittance valves according to DIN EN 12380

Class	Installation below backflow level of connected drainage fixtures	Temperature range
A I	yes	-20 °C to +60 °C
A II	yes	0 °C to +60 °C
A III	yes	0 °C to +20 °C
B I	no	-20 °C to +60 °C
B II	no	0 °C to +60 °C
B III	no	0 °C to +20 °C

#### Normative requirements for the use of air-admittance valves in areas susceptible to frost

Only air-admittance valves which are classified in Class I may be installed.

#### Requirement of DIN EN 12056-1, section 5.8, regarding frost protection:

Drainage systems must be planned and installed in such a way as to avoid the risk of their being destroyed or ceasing to function as a result of frost damage.

#### Maintenance in accordance with DIN 1986-3

Air-admittance valves are in accordance with DIN 1986-3:2004-11 subject to an inspection every 12 months.

As a rule, air-admittance valves are maintenance free. But as is the case with all air-admittance valves soiling can accumulate on the membrane.

#### Installation recommendation according to DIN 1986-100

#### Installation possibilities for air-admittance valves in downcomer pipes

- In detached and semi-detached houses or in comparable household waste water usage situations.
- Prerequisite is that at least one downcomer pipe with the shortest flow distance to the collecting drain at roof level is two-way vented. The downcomer pipe may not be reduced.

#### Installation possibilities for air-admittance valves in single and multiple connection pipes

- As a replacement for recirculation and indirect secondary ventilation
- At the end point of multiple and single connection pipes

Air-admittance valves are to be installed such that they can be replaced without any structural work being needed in the case of a defect. A sufficient inflow of air must be provided. Our built-in wall boxes on pages 13-16 meet these requirements.

## GENERAL INFORMATION

### Air-admittance valves for waste water pipes



#### Installation description

Air-admittance valves are used in order to create a balance of pressure in gravity drainage systems.

- Absolutely vertical installation is essential. Slantingly or horizontally installed air-admittance valves will not function.
- Accessibility for compulsory maintenance must be ensured (see built-in wall boxes, pages 13-16).
- In case of installation in concealed locations, a sufficient air supply must be available.
- If fitted to a horizontal waste pipe, the air-admittance valve must be installed at least one pipe-thickness vertically above the level of the pipe.
- Outdoor installation is not permissible. (Special solution: ventilair® for outdoor use)

**Air-admittance valves may be used below the backflow level to ventilate pipes when they are connected above the highest sanitary fixture.**

ventilair® air-admittance valves may also be installed upstream of a lifting system below the backflow level (see ventilair active® too in connection with lifting systems).

#### Advantages of installing air-admittance valves instead of conventional rooftop ventilation

- No damage to the building as a result of pipes penetrating delicate roofs such as flat roofs and thatched roofs.
- No heat loss thanks to closed system, particularly relevant to old buildings where waste water pipes are not insulated, e.g. in top floor flats.
- Particularly suitable for low-energy houses and passive houses.
- Reduces the risk of open main ventilation pipes freezing up.
- Creates the necessary conditions for the (subsequent) ventilation of waste systems inside buildings. Water drains away more efficiently in vulnerable pipe areas.
- If there is a fire, the risk of fire and fumes spreading via the drainage system is reduced as the chimney effect is eliminated.
- Flexibility in the planning of drainage system ventilation.
- Cost savings thanks to quick installation.

#### Installation situations where air-admittance valves cannot be used

- In areas where there is a risk of backflow.
- On containers, e.g. lifting or separator systems.
- In installation situations where only a horizontal or slanting position is possible.

**Air-admittance valves for waste water pipes**

- Fitter-compliant installation
- Compact and streamlined design, ideal for concealed use
- Reliable product with factory warranty
- Guaranteed safety via appropriate test certificates

ventilair® air-admittance valves are classified in the highest type classification Class A I.

This classification is documented by the attached CE mark.

The logo "Type-tested and monitored" by TÜV Rheinland LGA Products GmbH proves third-party control and compliance with DIN EN 12380.

Class A means:

suitable for installation below the backflow level of the connected drainage fixtures.

The air-admittance valve must be tested at 30 Pa, 500 Pa and 10,000 Pa.

Class I means:

suitable for a temperature range of between -20 °C and +60 °C.



**Valve function**

Our air-admittance valves already open ① when there is negative pressure in the pipe system, and close ② again after ventilation to become impermeable to odours and water. If there is a balance of pressure in the system, the valve remains closed.

**Important note**

If the cross-section of the drainage system is reduced, a backflow develops. The positive pressure that is created means that the valve remains closed. The necessary intake of air can thus not take place. This problem cannot be solved by using air-admittance valves.

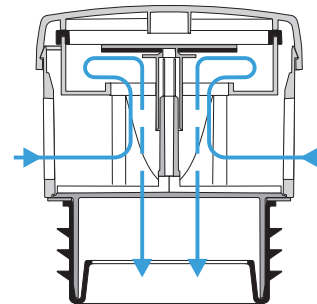

Valve is open ①

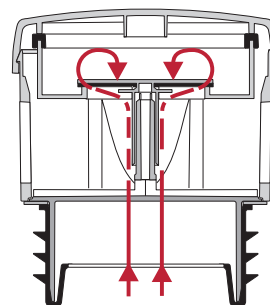

Valve is closed ②

### Nominal diameters

Our systems can each be fitted to pipes of three different sizes:  
DN 30-40-50, G 1½, DN 40-50 and DN 70-90-100.

For non-standard pipe dimensions adapters must be used.

### Maintenance

The compact and service-friendly design of the valves makes it easy to maintain and inspect them.

### Frost protection

The upper part of the polystyrene packaging serves as frost protection cover.

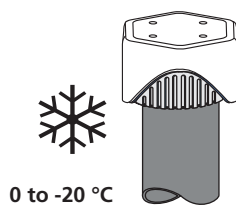

Code No. 11.A20.00..0099

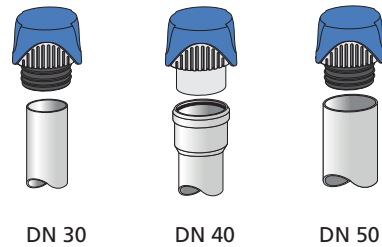

Code No. 11.020.00..S099  
with thread

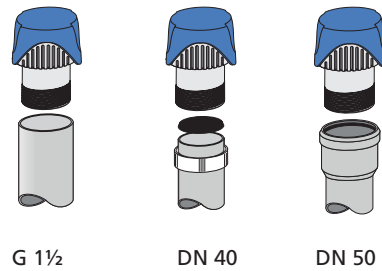

Code No. 11.A21.00..0099

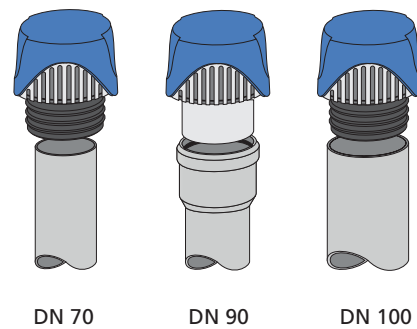

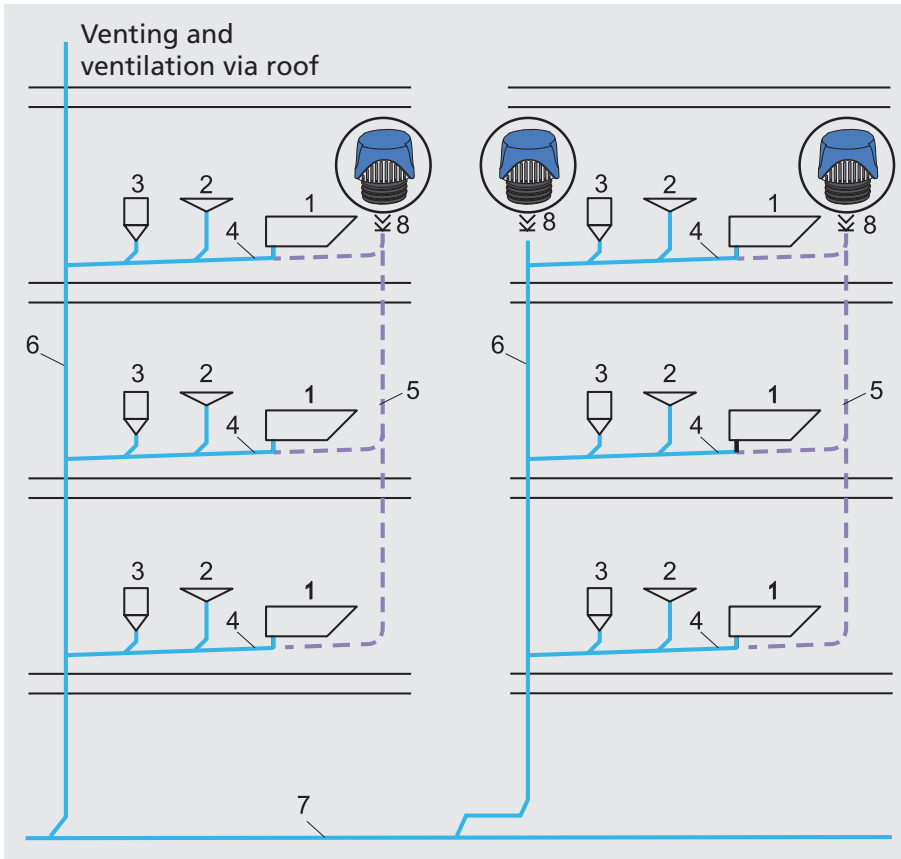

Installation options for air-admittance valves in downcomer and multiple connection pipes

Aeration of downcomer pipes with ventilair®

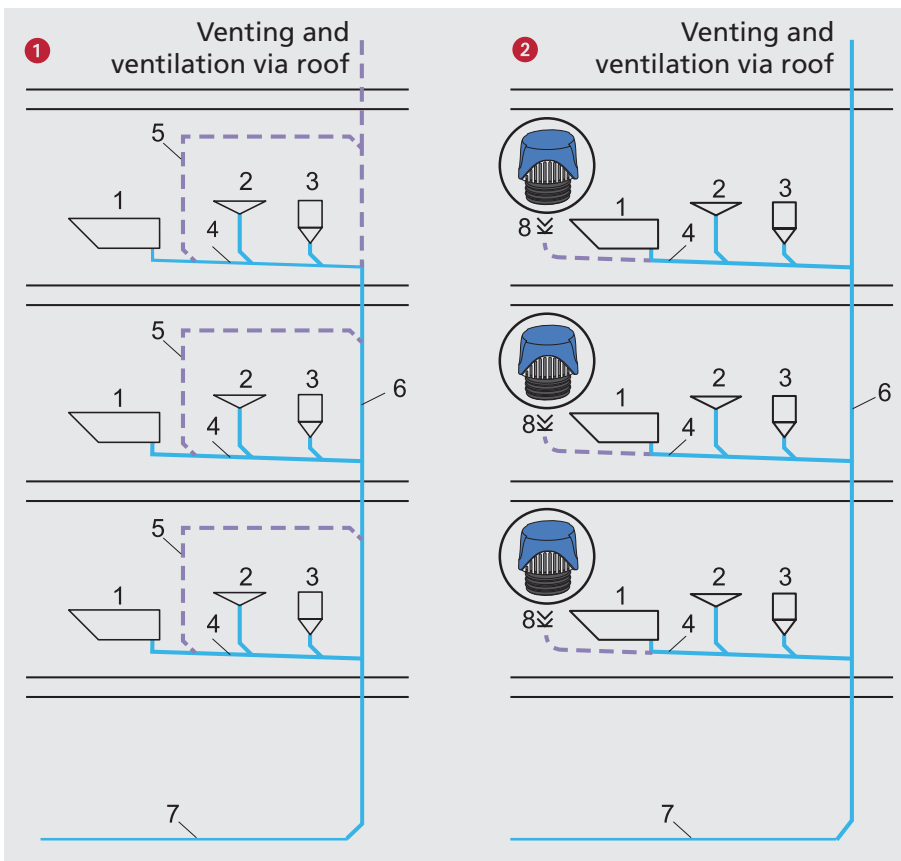

Aeration of multiple connection pipes

- 1 Recirculation ventilation
- 2 Aeration with ventilair®

- 1 Bathtub
- 2 Washbasin
- 3 WC
- 4 Connecting pipe
- 5 Recirculation ventilation
- 6 Downcomer pipe
- 7 Ground pipe
- 8 Air-admittance valve

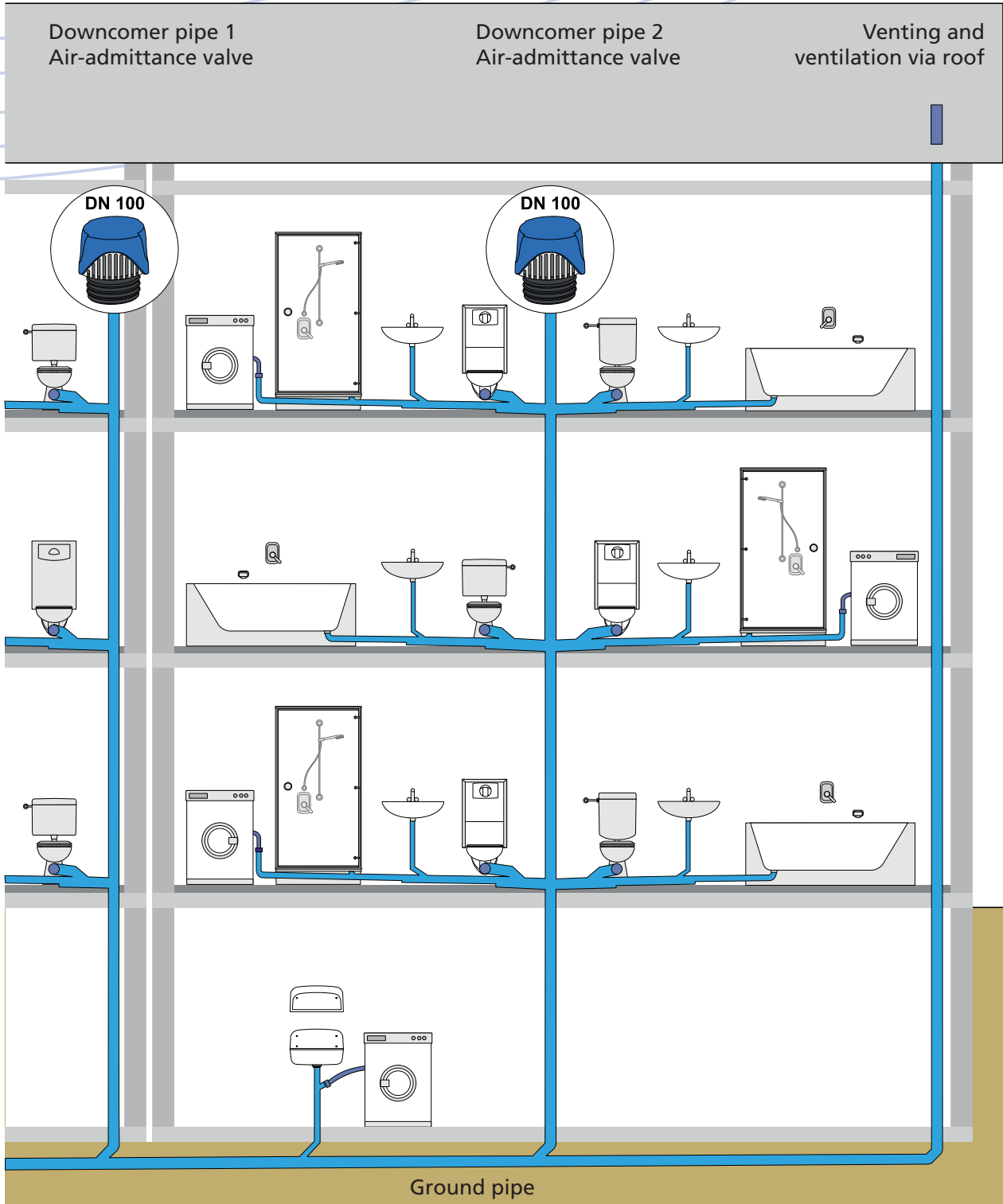



### Example calculation of air flow

Calculation of the air flow for a downcomer pipe in a 3-storey block of flats

The following sanitary appliances are connected	DU L/s
6 WCs with up to 7.5 L	12.0 (6 x 2.0)
6 washbasins	3.0 (6 x 0.5)
3 bathtubs	2.4 (3 x 0.8)
3 showers	1.8 (3 x 0.6)
3 washing machines	2.4 (3 x 0.8)
<b>DU</b>	<b>= 21.6 L/s</b>

Calculation of air flow	
<b>DU = 21.6 L/s</b>	
<b><math>Q_{ww} = K \times \sqrt{\sum DU}</math></b>	
<b><math>Q_{ww} = 0.5 \times \sqrt{21.6}</math></b>	
<b><math>Q_{ww} = 0.5 \times 4.64</math></b>	
<b><math>Q_{ww} = 2.32 \text{ L/s}</math></b>	
<b><math>Q_a = Q_{ww} \times 8</math></b>	
<b><math>Q_a = 18.59 \text{ L/s}</math></b>	

DU	= connection value for sanitary appliances in L/s
K	= drainage index corresponds to the frequency of use of sanitary appliances (0.5 in detached and semi-detached houses)
Q <sub>ww</sub>	= waste water drainage in L/s
Q <sub>a</sub>	= required air flow in L/s
8	= factor for downcomer pipe

Air flow for ventilair®	
Through-flow quantity in L/s with 2.5 mb negative pressure in the waste pipe system	
<b>DN</b>	<b>Art.no. 11.A20.00..0099</b>
50	7.5 L/s
40	8.0 L/s
30	7.0 L/s
<b>DN</b>	<b>Art.no. 11.A21.00..0099</b>
100	25.0 L/s
90	26.0 L/s
70	23.0 L/s
<b>DN</b>	<b>Art.no. 11.020.00..S099</b>
G 1½	8.0 L/s
50	8.0 L/s
40	7.5 L/s
<b>DN</b>	<b>Art.no. 11.A22.00..0099</b>
100	33.0 L/s
90	33.0 L/s
70	29.0 L/s

**NOTE:**

Up to eight complete bathroom units can be connected to the current DN 70-100 air-admittance valve. A bath unit consists of a WC, a washbasin, a bathtub and a shower or washing machine.

## Non-residential buildings, residential complexes and multi-storey buildings

ventilair® air-admittance valves are classified in the highest type classification Class A I.

They are tested and independently monitored by TÜV Rheinland LGA Products GmbH for their compliance with DIN EN 12380.

ventilair® air-admittance valves can as such be installed in all drainage systems subject to the DIN EN 12056 and DIN 1986-100 standards within the framework of the application options stated.

**Usage in multiple and individual connection pipes is possible and sensible in all cases irrespective of the height of the building and the length of the downcomer pipe.**

**According to DIN 1986-100 air-admittance valves may not, however, be used for aerating downcomer pipes in non-residential buildings, residential complexes and multi-storey buildings.**

## Usage in multiple and individual connection pipes

Air-admittance valves are installed as near as possible to the end of multiple and individual connection pipes to improve the drainage performance in the apartments/units on one storey. The aeration of each individual horizontal piping section is as such guaranteed.

Aerating is required from a certain length of the multiple or individual connection pipes. The use of air-admittance valves then offers major benefits as compared with the installation of secondary or recirculation ventilation systems: reduction in installation time, cost and materials.

## Installation options

- As a replacement for recirculation and indirect secondary ventilation
- At the end point of multiple and individual connection pipes

**This applies to buildings such as schools, hospitals, halls and stadiums as well as large residential complexes and multi-storey buildings.**

The air flow is generally calculated using the formula set out on pages 8-9.

The drainage index K can vary depending on the type of building concerned (see table).

The Scala Hotel in the Jentower in Jena is equipped with ventilair®

### Planning benefits

- Multiple and individual connection pipes can be run longer as their aeration with air-admittance valves is uncomplicated
- Material and space savings thanks to elimination of recirculation and secondary circulation ventilation
- Drainage performance is improved in the drainage system
- Built-in wall boxes make installation easy in interior or non-residential areas (see pages 13-16)

### Drainage index (K) in accordance with DIN 1986-100

Building type and usage	K
<b>Irregular usage,</b> e.g. in residential houses, nursing homes, guest houses, offices	0.5
<b>Regular usage,</b> e.g. in hospitals, schools, restaurants, hotels	0.7
<b>Frequent usage,</b> e.g. in public toilets and/or showers	1.0

At a pipe gradient of 1.5 cm/m and a volumetric flow of 0.8 m/s, the filling index amounts to 0.5 (50 % water, 50 % air at a ratio of 1:1)

At a filling index in the **connecting pipe** of 0.7 (70 % water, 30 % air) or 1.0 (100% water), the air flow to be calculated amounts to  $1:2 = Q_{ww} \times 2$

In **downcomer pipes** the air flow to be calculated amounts to  $1:8 = Q_{ww} \times 8$

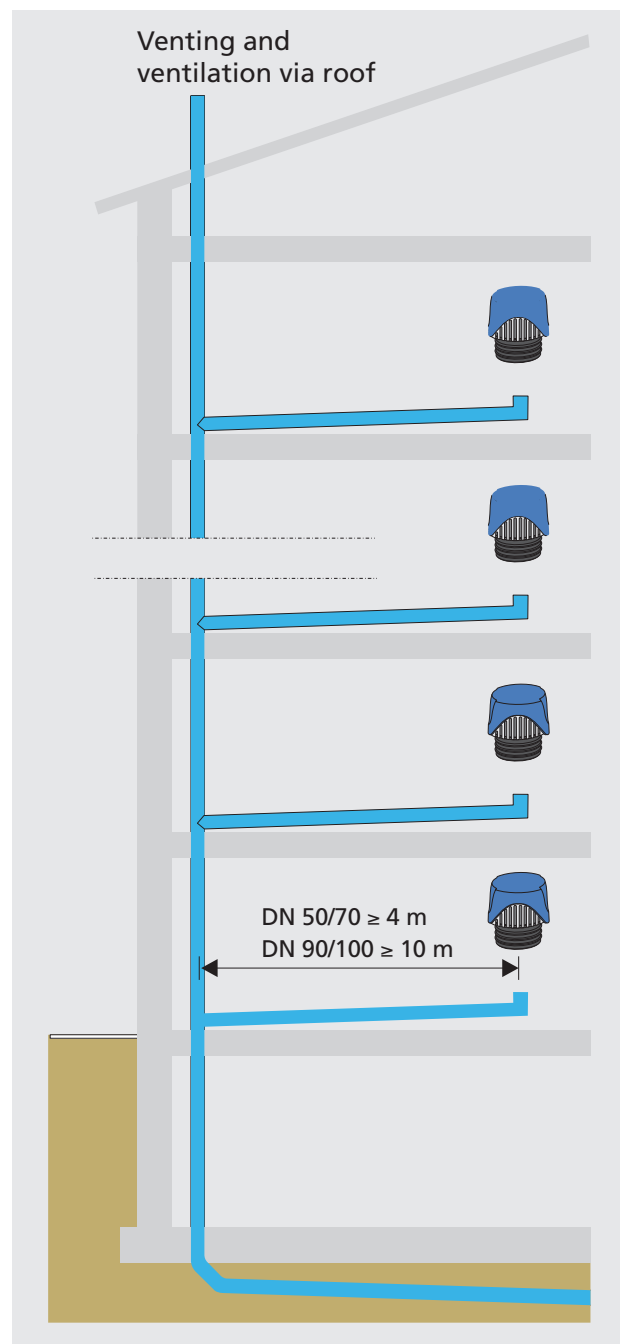

## ventilair®

The ventilair® air-admittance valves are type-tested and monitored according to DIN EN 12380, type classification Class A I, by TÜV Rheinland LGA Products GmbH. Temperature range from -20 °C to +60 °C, with rubber connectors and a polystyrene frost protection cover.

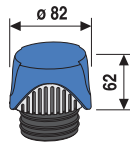

### DN 30-50 ventilair® air-admittance valve

Volumetric flow 8 L/s, with rubber connector for the dimensions stated

Model	Code No.
DN 30/40/50	11.A20.00..0099

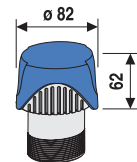

### G 1½, DN 40/50 ventilair® air-admittance valve

Volumetric flow 8 L/s

Model	Code No.
G 1½, DN 40/50	11.020.00..S099

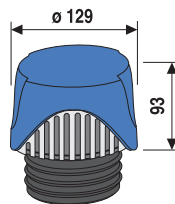

### DN 70-100 ventilair® air-admittance valve

Volumetric flow 25 L/s, with rubber connector for the dimensions stated

Model	Code No.
DN 70/90/100	11.A21.00..0099

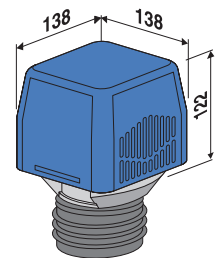

### ventilair® 33 air-admittance valve

Volumetric flow 33 L/s, with rubber connector for the dimensions stated

Model	Code No.
DN 70/90/100	11.A22.00..0099

ventilair®

### Plastic trap connectors with ventilair® air-admittance valves

We recommend trap connectors combined with ventilair® air-admittance valves for use in kitchens and cellars. They are suitable for retrospective installation under sinks improving drainage performance. The trap connector is size G 1½.

A typical application area is the **kitchen**. Grease and oil content in the waste water from sinks and dishwashers can cause deposits in waste water pipes over the years. Unfavourable circumstances (a multitude of bends, long piping) can make cleaning inevitable in many cases.

By installing an air-admittance valve, drainage performance is improved and the formation of deposits due to grease and oil residue and the clogging of pipes delayed.



### Plastic trap connectors with ventilair® air-admittance valves

G 1½, plastic, with 250 mm connection pipe and hose tap, in accordance with DIN (approval no. 4 U 046), extension pipe with ventilair® air-admittance valve, volumetric flow 8 L/s, **with additional testing to DIN EN 274, temperature range up to +95 °C.**

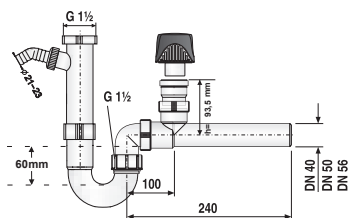

### ventilair® air-admittance valve DN 30-50 for horizontal connection

type-tested and monitored in accordance with DIN EN 12380, type class A I, volume flow 8 l/sec, temperature range -20°C, with polystyrene frost protection cover, with rubber connector for the dimensions stated

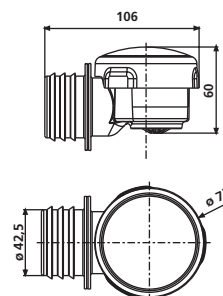

Model	Code No.
G 1½ x DN 40	03.001.00..0099
G 1½ x DN 50	03.002.00..0099
G 1½ x DN 56	03.016.00..0099

Size	Code No.
suitable for DN 30/40/50	11.031.00..0099

## ventilair®

### Built-in wall boxes

According to DIN 1986-3:2004-11 inspection and maintenance of air-admittance valves are to be conducted every 12 months. Air-admittance valves must therefore be installed such that they are easily accessible in all cases. Our built-in boxes are the ideal solution here.

### Built-in wall boxes with a plastic cover plate

Built-in boxes made of plastic, stylish cover plate in Alpine white. The openings integrated into the plate guarantee an adequate supply of air. The plate can be easily removed for maintenance/inspection thanks to a spring mechanism.

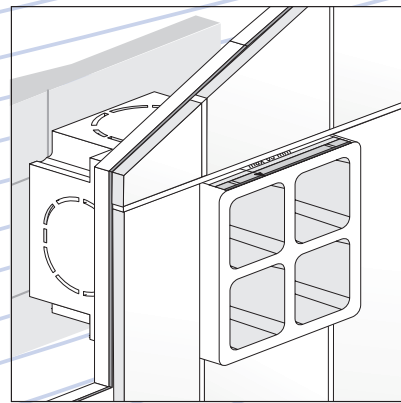

### Built-in wall box with DN 30-50 ventilair® air-admittance valve

Box dimensions:  $w \times h \times d = 130 \times 150 \times 93$  mm, mounting frame for cover plate, plastic cover plate, UV resistant,  $w \times h = 165 \times 190$  mm, Alpine white.

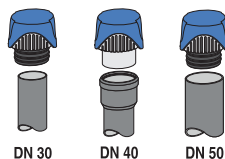
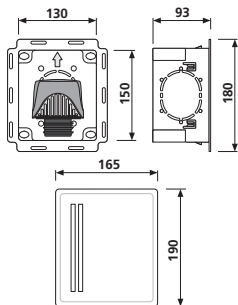

### Built-in wall box with DN 70-100 ventilair® air-admittance valve

Box dimensions:  $w \times h \times d = 200 \times 210 \times 133$  mm, mounting frame for cover plate, plastic cover plate, UV resistant,  $w \times h = 235 \times 250$  mm, Alpine white.

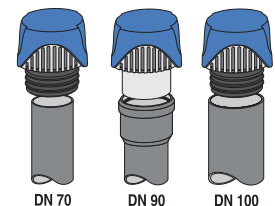
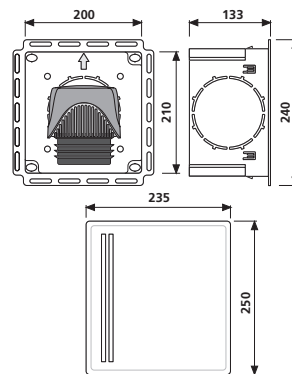

Model	Code No.
with ventilair®	17.270.01..0099

Model	Code No.
with ventilair®	17.271.01..0099

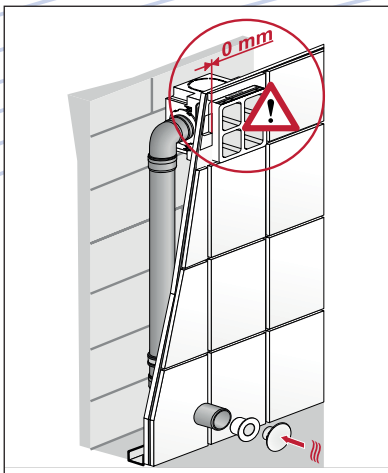

The installation of an air supply pipe to ensure that the air-admittance valve is provided with sufficient amount of air is a mandatory requirement.

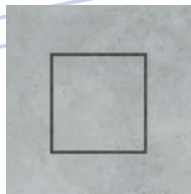

Optional: jointing with silicone after final installation of the cover plate.



The galvanised metal cover plate can optionally be tiled, varnished or wallpapered.

## ventilair®

Built-in wall boxes for flush installation, with external air supply, built-in boxes made of plastic, with depth-adjustable magnets for the flush installation of the metal cover plate. The cover plate can be tiled, varnished or wallpapered and can be easily removed for maintenance/inspection. A cover cap made of plastic for the air supply pipe is supplied as standard, Alpine white in colour.



### Built-in wall box for flush mounting, with DN 30-50 ventilair® air-admittance valve

Box dimensions: w x h x d = 130 x 150 x 93 mm, integrated magnets for flush alignment of the cover plate, adapter for air inlet pipe suitable for connection on 3 sides (DN 50 HT pipe, not included), cover cap for DN 50 air inlet pipe with integrated air inlet openings, Alpine white, galvanised metal cover plate, w x h = 115 x 135 mm, 2 suction cup holders for removing the cover plate.

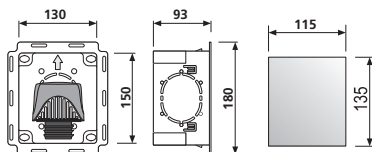

Model	Code No.
with ventilair®	17.270.00..0099



### Built-in wall box for flush mounting, with DN 70-100 ventilair® air-admittance valve

Box dimensions: w x h x d = 200 x 210 x 133 mm, integrated magnets for flush alignment of the cover plate, adapter for air inlet pipe suitable for connection on 3 sides (DN 90 HT pipe, not included), cover cap for DN 90 air inlet pipe with integrated air inlet openings, Alpine white, galvanised metal cover plate, w x h = 185 x 195 mm, 2 suction cup holders for removing the cover plate.

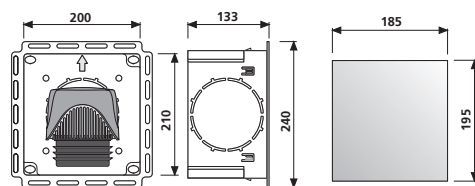

Model	Code No.
with ventilair®	17.271.00..0099

## ventilair®

Built-in boxes made of plastic, stylish cover plate in Alpine white. The openings integrated into the plate guarantee an adequate supply of air. The plate can be easily removed for maintenance/inspection thanks to a spring mechanism.



### Built-in wall box suitable for DN 30-50 ventilair®, DN 30-50 ventilair duplex®, G 1½, DN 40/50 ventilair®, G 1½, DN 40/50 ventilair duplex®

Box dimensions: w x h x d = 130 x 150 x 93 mm, mounting frame for cover plate, plastic cover plate, UV resistant, w x h = 165 x 190 mm, Alpine white.

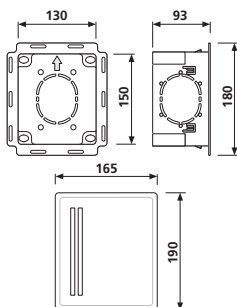

### Built-in wall box suitable for DN 70-100 ventilair®, DN 70-100 ventilair duplex®, DN 70-100 ventilair active®

Box dimensions: w x h x d = 200 x 210 x 133 mm, mounting frame for cover plate, plastic cover plate, UV resistant, w x h = 235 x 250 mm, Alpine white.

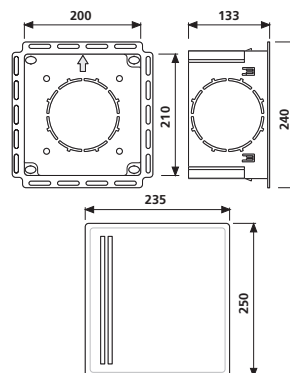

Model	Code No.
without ventilair®	17.270.01..S099

Model	Code No.
without ventilair®	17.271.01..S099





## ventilair®

Built-in wall boxes for flush installation, with external air supply, built-in boxes made of plastic, with depth-adjustable magnets for the flush installation of the metal cover plate. The cover plate can be tiled, varnished or wallpapered and can be easily removed for maintenance/inspection.



**Built-in wall box for flush mounting, suitable for DN 30-50 ventilair®, DN 30-50 ventilair duplex®, G 1½, DN 40/50 ventilair®, G 1½, DN 40/50 ventilair duplex®**

Box dimensions: w x h x d = 130 x 150 x 93 mm, integrated magnets for flush alignment of the cover plate, adapter for air inlet pipe suitable for connection on 3 sides (DN 50 HT pipe, not included), cover cap for DN 50 air inlet pipe with integrated air inlet openings, Alpine white, galvanised metal cover plate, w x h = 115 x 135 mm, 2 suction cup holders for removing the cover plate.

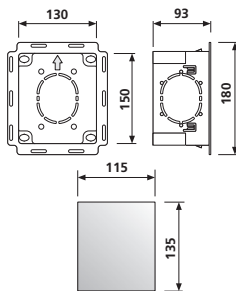

Model	Code No.
without ventilair®	17.270.00..S099



**Built-in wall box for flush mounting, suitable for DN 70-100 ventilair®, DN 70-100 ventilair duplex®, DN 70-100 ventilair active®**

Box dimensions: w x h x d = 200 x 210 x 133 mm, integrated magnets for flush alignment of the cover plate, adapter for air inlet pipe suitable for connection on 3 sides (DN 90 HT pipe, not included), cover cap for DN 90 air inlet pipe with integrated air inlet openings, Alpine white, galvanised metal cover plate, w x h = 185 x 195 mm, 2 suction cup holders for removing the cover plate.

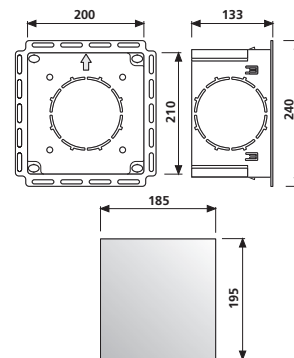

Model	Code No.
without ventilair®	17.271.00..S099

ventilair®

### Air-admittance valve for outdoor use, unheated

The solution for combating disturbing smells coming from freely vented downcomer pipes

- On roof terraces
- Next to skylights
- Next to dormer windows
- Next to roof windows on gable roofs
- On terraces and balconies
- Disturbing smells from drains are prevented in the long term

Type-tested according to DIN EN 12380, type classification Class A I, volumetric flow 24 L/s, frost-resistant and weatherproof, suitable for DN 70/90/100 and inside diameters from 113 to 127 mm.



### ventilair® air-admittance valve for outdoor use, unheated

For replacing open waste water pipe vents in locations where disturbing odours arise from freely vented downcomer pipes, e.g. on roof terraces, next to skylights, dormer windows and roof windows on gable roofs, on terraces and balconies, etc.

Volumetric flow 24 L/s, with additional protective cover made from UV resistant plastic, with rubber connectors for the dimensions stated.

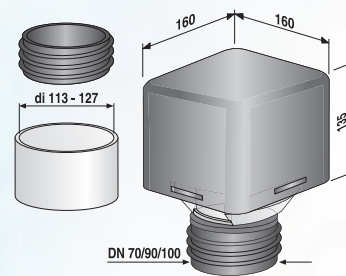
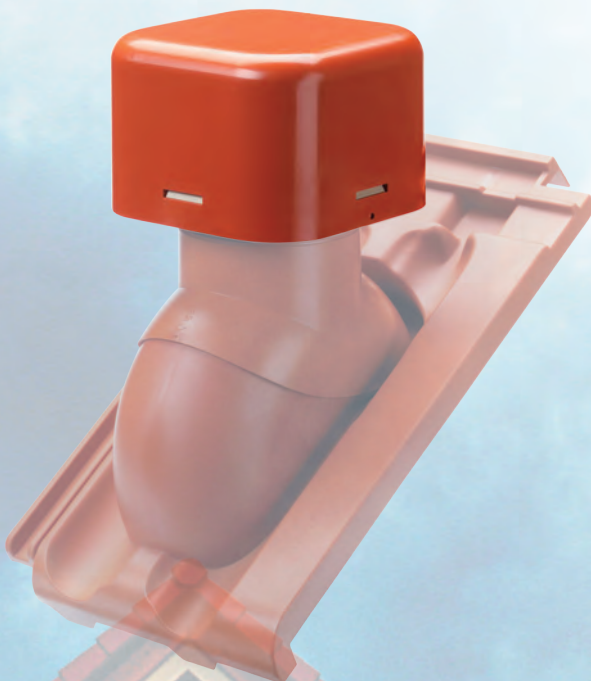

Colour / Model	Code No.
Brick-red, suitable for DN 70/90/100 and ID 113 to 127 mm	11.A23.00..0099
Black, suitable for DN 70/90/100 and ID 113 to 127 mm	11.A23.00..S099

ventilair®

**Air-admittance valve for outdoor use, heated**

- Frees the air-admittance valve from snow and ice
- Prevents the valve from freezing up
- Creates a ring-shaped gap thus permitting air to feed in



**ventilair® air-admittance valve for outdoor use, heated**

With integrated, self-regulating thermostat, suitable for DN 90/100 and inside diameters from 113 to 127 mm, not subject to third-party monitoring.

Heating band specifications:  
Switches on automatically at +5 °C, for use down to -40 °C, completely watertight, 1 m silicone connection cable, double insulated, highly flexible, for direct connection to 230V AC, 40 W power.

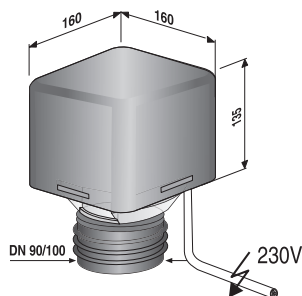

Colour / Model	Code No.
Brick-red, suitable for DN 90/100 and ID 113 to 127 mm	11.026.00..0099

## Air-admittance valves for the ventilation of individual objects

### Chrome-plated brass trap connectors with chrome-plated air-admittance valves in accordance with DIN EN 12380

A typical case of individual object aeration is the sink in the **bathroom or guest WC**. The unfavourable running of pipes or arrangement of objects can cause the trap to make a gurgling noise or be sucked dry (smell development).

This often happens when for example waste water is being pumped out of a washing machine that is connected to the same drain pipe and is closer to the downcomer pipe. An air-admittance valve ensures in such cases that sufficient air is supplied and no disturbing noises or smells develop.

There are special trap connectors with air-admittance valves for unconcealed installation for such applications. Installation is possible retrospectively and without any difficulty whatsoever.

**Tested according to DIN EN 12380, type classification Class A II, temperature range from 0 °C to +60 °C, for connection to standard traps of Ø 32 in order to improve drainage performance.**



### 90° waste bend

L = 250 mm, Ø 32, with G 1¼ cap nut, chrome-plated brass, with high-gloss chrome-plated G ½ air-admittance valve, type classification Class A II, volumetric flow 2 L/s, temperature range from 0 °C to +60 °C.

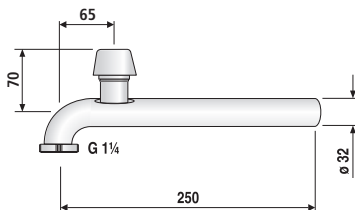

Model	Code No.
G 1¼ x Ø 32 x 250	03.091.00..0000



### Straight waste pipe

L = 250 mm, Ø 32, chrome-plated brass, with high-gloss chrome-plated G ½ air-admittance valve, type classification Class A II, volumetric flow 2 L/s, temperature range from 0 °C to +60 °C.

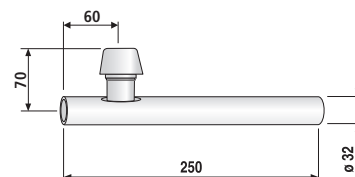

Model	Code No.
Ø 32 x 250	03.089.00..0000

## Air-admittance valves for the ventilation of individual objects

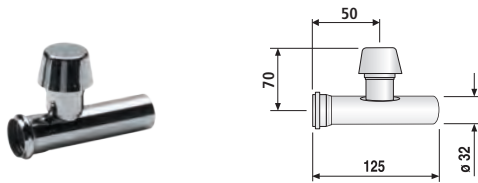

### Extension pipe with sleeve

L = 125 mm, Ø 32, chrome-plated brass, with high-gloss chrome-plated G ½ air-admittance valve, type classification Class A II, volumetric flow 2 L/s, temperature range from 0 °C to +60 °C.

Model	Code No.
ø 32 x 125	03.090.00..0000

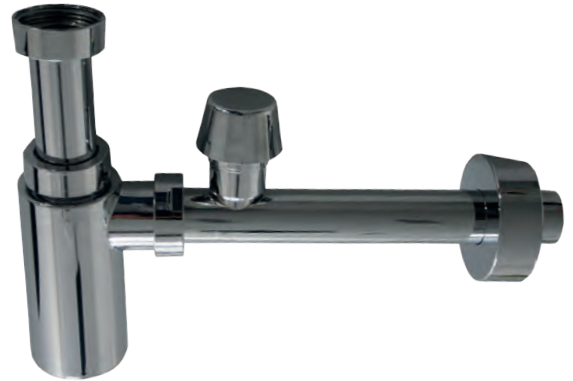

### Air-admittance valves for the ventilation of individual objects according to DIN EN 12380

Tested according to DIN EN 12380, type classification Class A II, suitable for installation below the backflow level of the connected drainage fixture, temperature range from 0 °C to +60 °C, volumetric flow 2 L/s to 3.3 L/s.

Model	Code No.
DN 30	11.A00.00..0099
DN 40	11.A01.00..0099
DN 50	11.A02.00..0099
DN 70	11.A03.00..0099
ø 100	11.A05.00..0099
DN 100	11.A04.00..0099

## ventilair active®

### Two-way vent valve with activated carbon filter for tanks

#### Function

The ventilair active® is not comparable with a conventional air-admittance valve. It does not have a valve operating mechanically but works as a two-way system whereby all the air passes via a multi-layer activated carbon filter pad.

When positive pressure develops, e.g. when filling lifting systems or tanks, the ventilair active® (see chart 1 on page 29 and figure 1 on page 24) vents and at the same time neutralises any gases and smells developing via the activated carbon in the filter.

When waste water is pumped out of the lifting system, negative pressure occurs in the system which the ventilair active® compensates for via air intake (see chart 2 on page 29 and figure 2 on page 25).

#### Application options

The problem solver for the two-way venting of lifting systems, domestic sewer systems, existing open ventilation systems, e.g. individual oil tanks and septic tanks, with the simultaneous filtering of any gases that may develop. For micro lifting systems the DN 30-50 ventilair active® is available.



## ventilair active®

The application options of the ventilair active® are based on the DIN EN 12050 standard for lifting systems. The decision concerning usage of a ventilair active® is to be made on the basis of the classification of the lifting system.

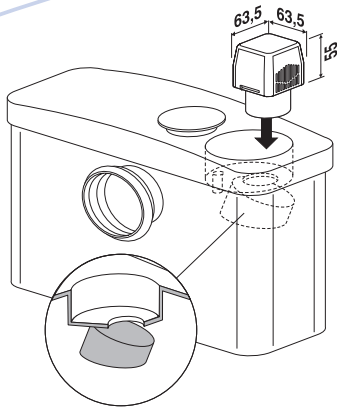

### DN 30-50 ventilair active®

For use in domestic micro lifting systems and faecal-free lifting systems for filtering arising gases. When odours are detected, the filter is exhausted and the two-way vent valve must be replaced. Air flow volume at 250 Pa = 0.39 L/s = 1.4 m<sup>3</sup>/h.

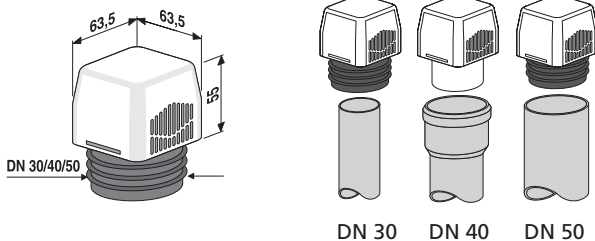

### Lifting systems according to DIN EN 12050 part 1

The ventilair active® must be installed in an accessible outdoor location if used in connection with waste water containing excrement to ensure that when the filter medium is saturated no gases can penetrate the indoor area and the filter cartridge can be replaced without difficulty.

Depending on the installation situation, the valve can be fitted vertically or horizontally (see figures 3 and 4). If installed horizontally, the ventilair active® is to be mounted so that it is protected from the weather (e.g. in a built-in wall box, art. no. 17.271.01..S099).

### Lifting systems according to DIN EN 12050 part 2

In the case of waste water free of excrement, the ventilair active® can also be used indoors providing that the lifting system is equipped with a backflow prevention system. Should this not be the case, the ventilair active® must be installed above the backflow level of the sanitary appliance connected.

### Lifting systems according to DIN EN 12050 part 3

For micro lifting systems the ventilair active® can also be used indoors even if the waste water is not free of excrement.

Model	Code No.
With rubber connector, suitable for DN 30/40/50	11.029.00..0099

Figure 1

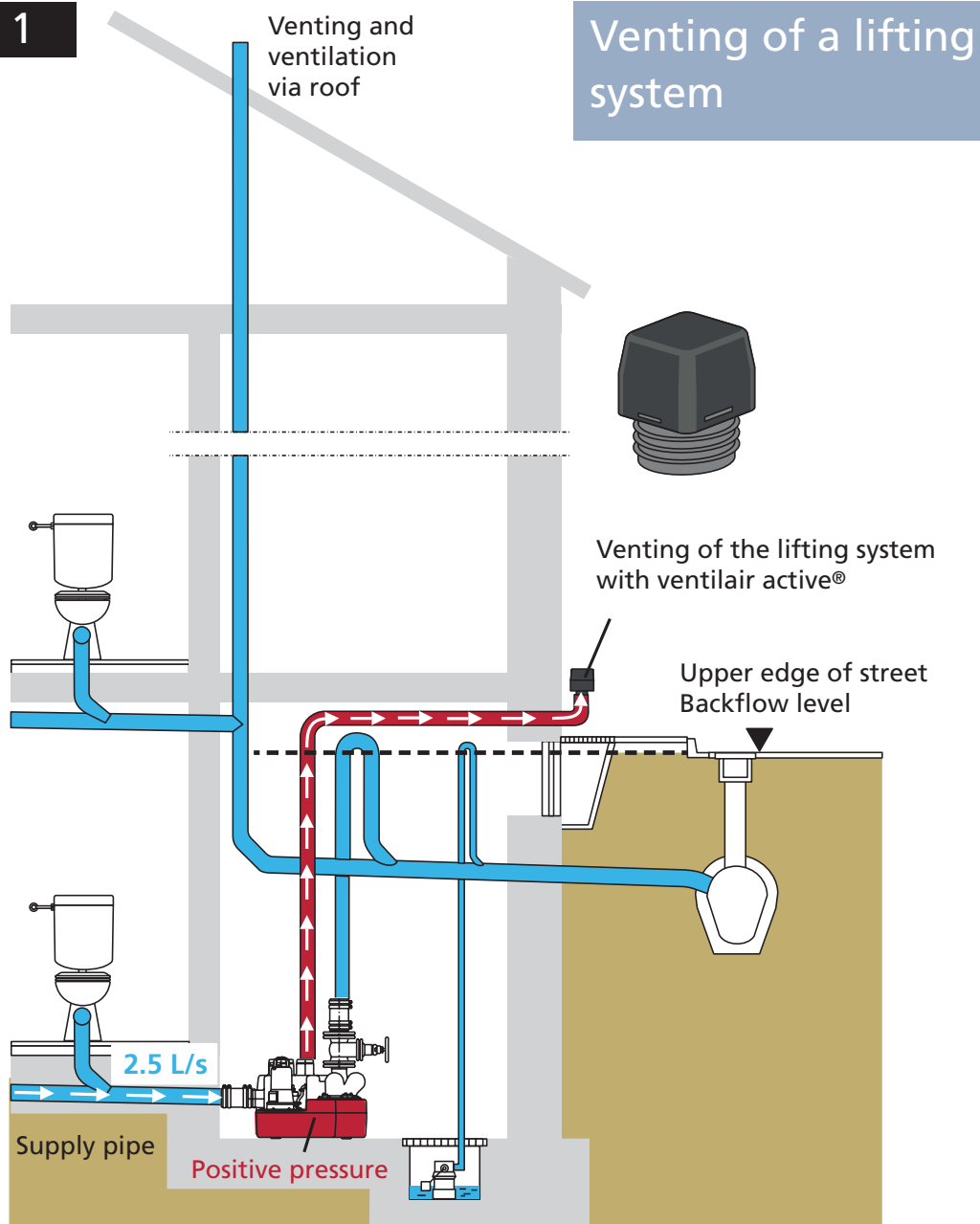



Figure 2

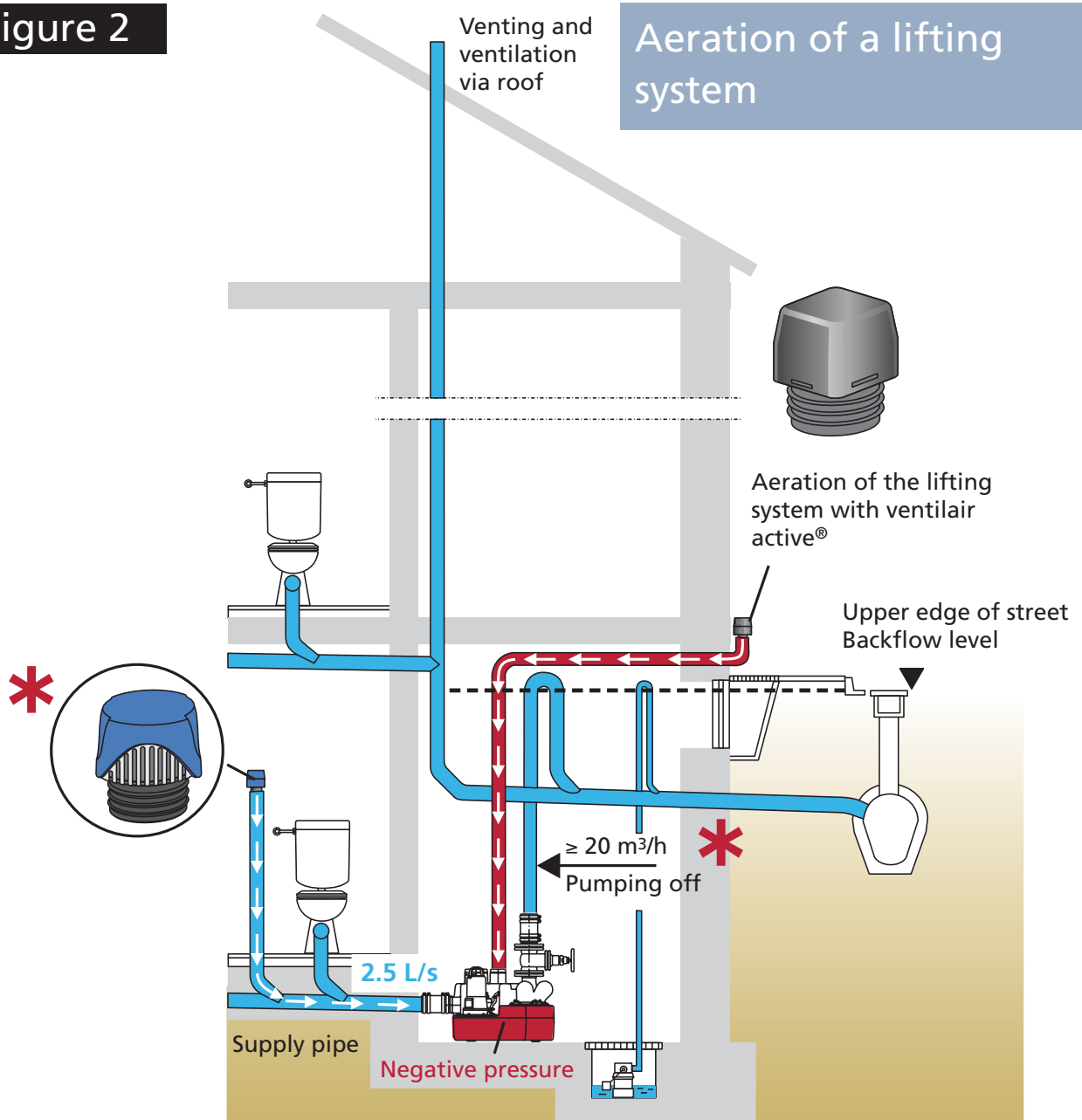

Figure 3

ventilair active® – vertical installation

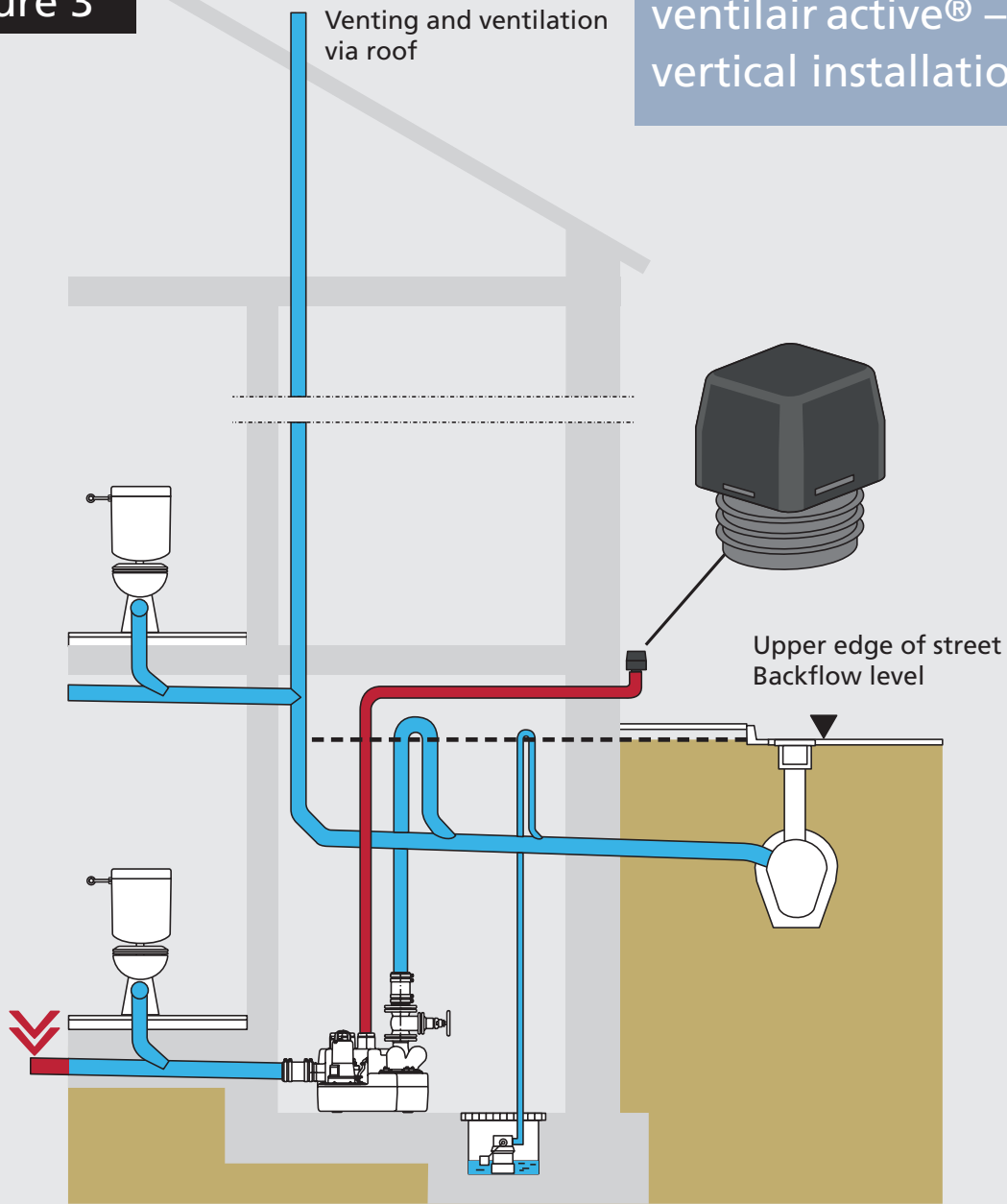
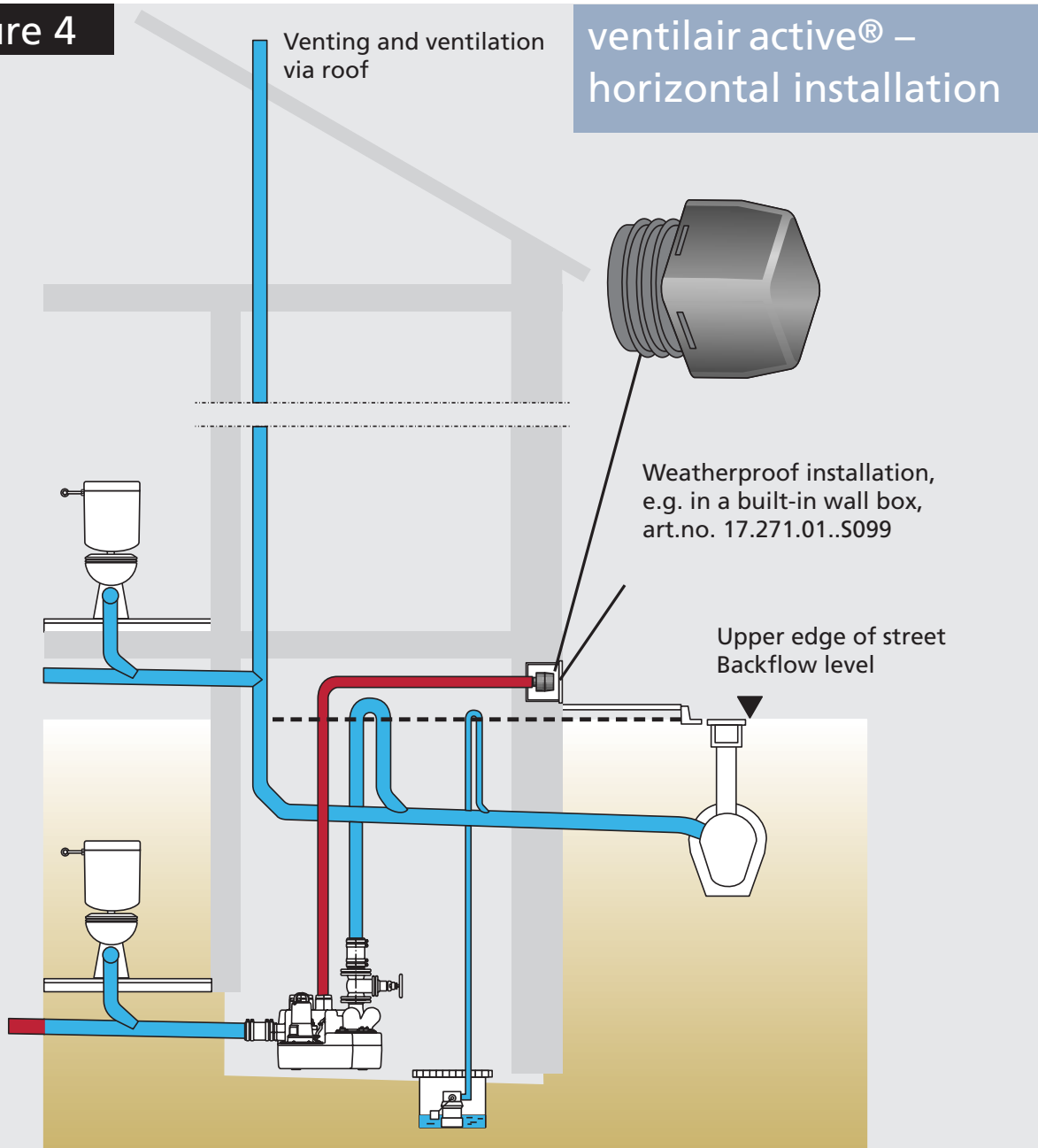

Figure 4





## Notes

- The ventilair active® must not be used for two-way venting of waste water downcomer pipes.
- With lifting systems  $\geq 20 \text{ m}^3$  pumping capacity an air-admittance valve must additionally be installed in the inflow pipe (see chart 2 on page 29 and figure 2 on page 25).
- The ventilair active® is UV resistant and frost-proof down to  $-20 \text{ }^\circ\text{C}$  as verified by TÜV Rheinland LGA Products GmbH following DIN EN 12380.
- As it is classed as a filter and, as such, not subject to the standards DIN EN 12056 and DIN 1986-100, it is to be considered purely as a problem-solver. For this reason, the installation of the ventilair active® should be contractually regulated.

## Filter cartridge

The filter cartridge contains a multi-layer fabric, impregnated with active carbon, and a protective fleece to protect against rising moisture. Depending on usage, it lasts for up to several years. We recommend also checking the activated carbon filter system when carrying out the required servicing of units in which the ventilair active® is installed.

## Maintenance

When odours are detected, it means the filter capacity is exhausted. In this case, open the cap of the ventilair active® and replace the filter cartridge.

**Performance data**

**Chart 1**

**Positive pressure (pressure drag)**

**Example:**

At a pressure volume of 8.2 m<sup>3</sup> = 2.28 L/s positive pressure of 250 Pa (= 25 mm of water column) occurs before the ventilair active®.

**Chart 2**

**Negative pressure**

**Example:**

At an intake volume of 3.33 L/s negative pressure of 250 Pa (= 25 mm of water column) occurs in the system.

With lifting systems  $\geq 20$  m<sup>3</sup> pumping capacity an air-admittance valve must additionally be installed in the inflow pipe. →

**Chart 1**

Ratio of air flow rate – positive pressure, measured at LGA

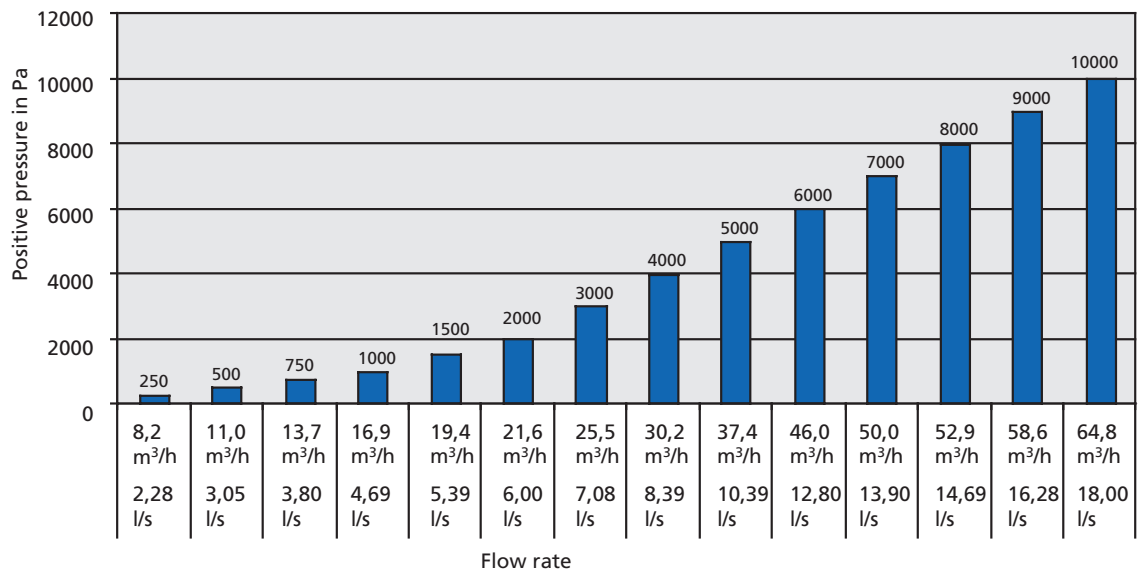

**Chart 2**

Ratio of air intake volume – negative pressure, measured at LGA

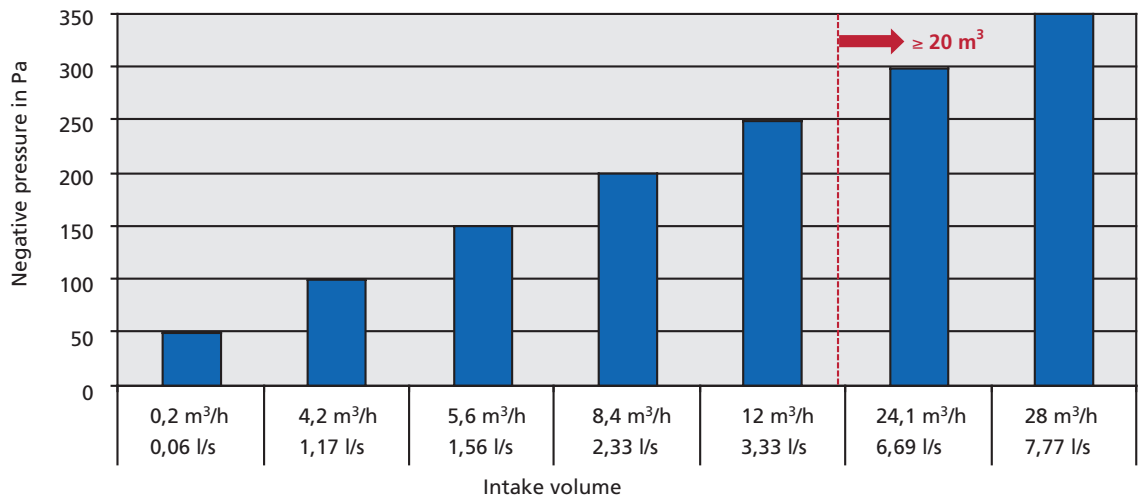



### DN 70-100 ventilair active®

Air flow volume at 250 Pa = 3.33 L/s = 12 m<sup>3</sup>/h, frostproof down to -20 °C following DIN EN 12380, UV resistant plastic cap, with rubber connector, for use in unpressurised areas.

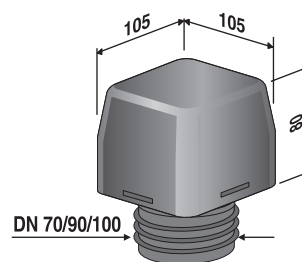

Model	Code No.
Suitable for DN 70/90/100	11.A24.00..0099

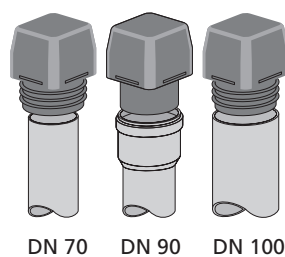

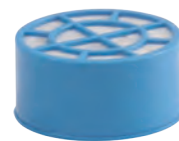

### ventilair active® with threaded connections

Air flow volume at 250 Pa = 3.33 L/s = 12 m<sup>3</sup>/h, frostproof down to -20 °C following DIN EN 12380, UV resistant plastic cap, with G 2 male thread for use at pressures of up to 1 bar, two additional reducers with G 1½ and G 1¼ male threads.

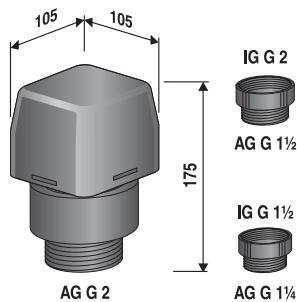

Model	Code No.
Suitable for connections with G 2, G 1½ and G 1¼ female threads	11.A24.00..S099

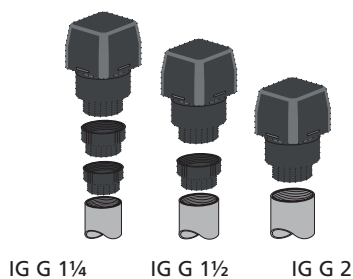

### Filter cartridge for ventilair active®

Suitable for  
art.no. 11.A24.00..0099  
art.no. 11.A24.00..S099

**Unlimited shelf life when stored dry**



	Code No.
	11.A25.00..0099

IG = female thread  
AG = male thread



**SANIT**

ventilair® / ventilair active®  
Applications  
Technical information

**LGAM Bauart geprüft**

**AIR-ADMITTANCE VALVES AND ACCESSORIES**  
[WWW.SANIT.COM](http://WWW.SANIT.COM)

**SANIT**

ventilair duplex  
The problem-solver for pressure compensation in drainage systems  
Two-way vent valves with activated carbon filter and float protection for waste water pipes

**PRESSURE COMPENSATION**  
[WWW.SANIT.COM](http://WWW.SANIT.COM)